

K J W O R K S

# Mk 1



# USER'S MANUAL



**WARNING:** BEFORE USAGE, THE INSTRUCTION MUST BE READ THOROUGHLY.

THIS GAS GUN IS DESIGNED ON THE PURPOSE OF PLEASURE THROUGH PROPER SHOOTING EXERCISE. IF THE FEATURE OF THE GUN AND NOTICE ITEMS WERE THOROUGHLY UNDERSTOOD, YOU WOULD HAVE A UNIQUE EXPERIENCE. ALSO, YOUR SHOOTING ABILITY WOULD BE STRENGTHENED. SINCE THE SHOOTING RANGE OF PLASTIC BB BULLET COULD REACH 40-50 METERS, IF YOU SHOT WITHOUT CAUTION OR USED IMPROPERLY, BLINDNESS OR INJURIES COULD BE LED. THE FOLLOWING ATTENTION POINTS AND INSTRUCTIONS ON EACH GUN UNIT MUST BE READ THOROUGHLY. AFTER UNDERSTANDING, THE SHOOTING EXERCISE SHOULD BE INITIATED FOLLOWING THE RULES AND POLITENESS.



**WARNING:**

DO NOT SHOOT DIRECTLY TO PEOPLE OR ANIMAL.



**WARNING:**

GUN AND GAS MUST NOT BE PLACED IN AREA WHERE TEMPERATURE IS OVER 40 DEGREES.



**WARNING:**

EYE PROTECTION DEVICE MUST BE EQUIPPED.



**WARNING:**

UNAUTHORIZED RECONSTRUCTION OF AIR GUN TO STRENGTHEN FIRING FUNCTION IS STRICTLY PROHIBITED.



**WARNING:**

PLACED IN GUN CASE WHEN NOT IN USE OR WHEN TRANSPORTING.



**WARNING:**

THIS GUN IS DESIGNED AFTER THE CONSIDERATION OF MOST APPROPRIATE FUNCTION AND OPERATION DECOMPOSITION, REMODELING AND DAMAGE OF INITIAL FUNCTION WOULD LEAD TO DANGER AND THEREFORE SHOULD NOT BE ATTEMPTED.

THE MUZZLE SHOULD NOT BE FACED TO ANY BREAKABLE OR DANGEROUS PRODUCT. (GRASS, LIGHT, ELECTRIC APPLIANCES)

NOTHING OTHER THAN THE BB BULLETS COULD BE LOADED IN THE MAGAZINE AND MUZZLE.

IF THE GAS IN THE FIREARM WAS BLOWN DIRECTLY TO BODIES, FROSTBITE AND SIMILAR SITUATION COULD BE CAUSED.

AVOID KEEPING THE FIREARMS IN PLACE WHERE THE FIREARM MIGHT BE ROLLED OVER. AND KEEP THEM AWAY FROM CHILDREN.

## ● NAME OF PARTS



## ● SAFETY

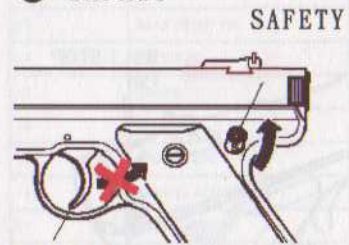

TRIGGER

YOU CAN NOT SHOT WHEN SAFETY IS IN SAFE POSITION. SHOOTING WHEN SAFETY IN SAFE POSITION MAY CAUSE DAMAGE.

## ● FILLING OF GAS

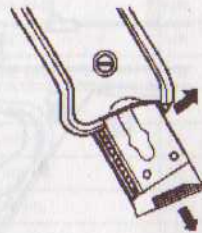

REMOVE THE MAGAZINE.

## ● LOADING OF BB BULLETS



PLACE THE MAGAZINE UPSIDE DOWN, THEN FILL THE GAS BOTTLE TO THE MAGAZINE IN VERTICAL DIRECTION.



PRESS THE FOLLOWER DOWN AND LOAD THE BB BULLETS.

※ PLEASE DO NOT LOAD OVER 17 BULLETS.

## ● SHOOTING

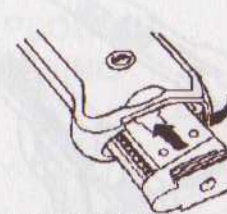

INSTALL THE MAGAZINE. CHECK TO SEE IF MAGAZINE LATCH PRODUCES A "CLICK" SOUND AND CLOSE TIGHTLY. DO NOT SHOOT WITHOUT MAGAZINE, IT MAY CAUSE DAMAGE.



START SHOOTING. SHOOTING CONTINUOUSLY FOR A LONG TIME WOULD CAUSE THE TEMPERATURE AND GAS PRESSURE WITHIN THE MAGAZINE TO BE LOWERED DOWN. THEREFORE, THE BULLETS COULD NOT BE SHOT STEADILY. THIS IS NOT DUE TO BREAKDOWN, AFTER A SHORT REST, IT WOULD RESUME TO NORMAL CONDITION.

## ● TRAJECTORY ADJUSTING

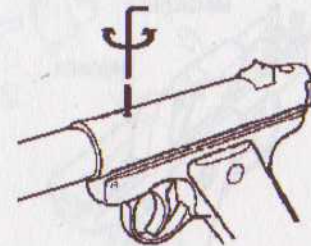

USING TOOL TO ADJUST TRAJECTORY.

※ THE BULLET COULD BE STUCK INSIDE THE CHAMBER THEN THE SCREW IS OVERED SCREWED.

PHENOMENON	WAY OF IMPROVEMENT.
MOVES UPWARD	SCREW UP.
LONGEST SHOOTING DISTANCE	HOLD THE ORIGINAL CONDITION.
NATURALLY FALL DOWN	SCREW DOWN.

## ● DISASSEMBLY

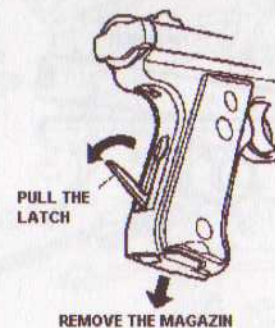

REMOVE THE MAGAZINE AND PULL THE LATCH LEVER OUT TOWARD THE REAR.

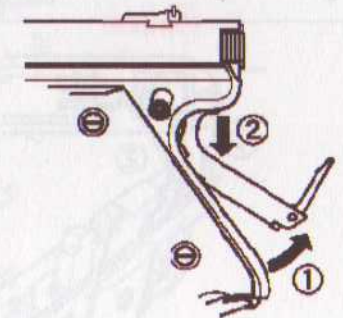

1. SWING THE MAINSPRING HOUSING OUT AND TURN IT UP TOWARD THE REAR
2. PULL THE HOUSING STRAIGHT DOWN TO THE BOLT-STOP PIN FROM THE FRAME AND BARREL EXTENSION.

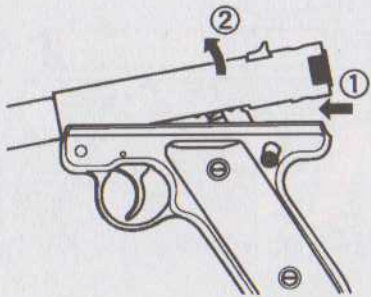

MOVE THE BARREL AND RECEIVER UNIT FORWARD TO FREE IT FROM THE INTERNAL HOOK AT THE FRONT OF THE FRAME.

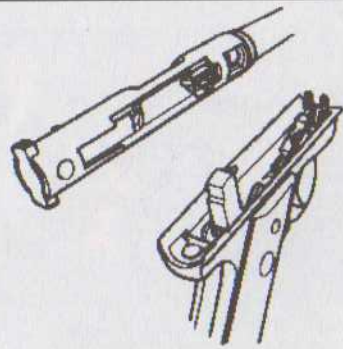

GUN IS NOW FIELD STRIPPED.

● REASSEMBLY

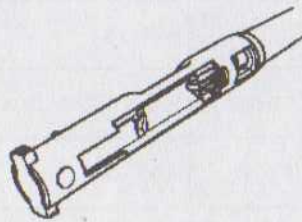

BE SURE ALL PARTS ARE IN RIGHT POSITION.

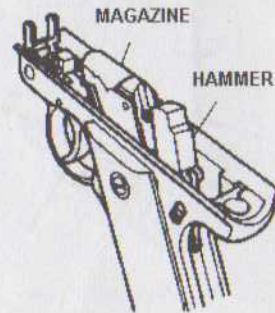

RELEASE THE GAS AND INSTALL THE MAGAZINE BACK AND PLACE THE HAMMER FORWARD.

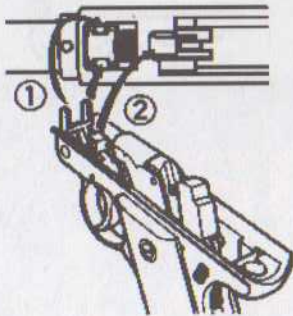

PLACE THE BARREL/RECEIVER ASSEMBLY ON THE FRAME.



BE SURE THE HAMMER IS IN FORWARD POSITION.

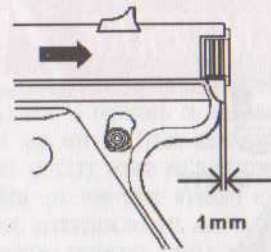

PUSH THE BARREL/RECEIVER BACKWARD ABOUT 1mm.

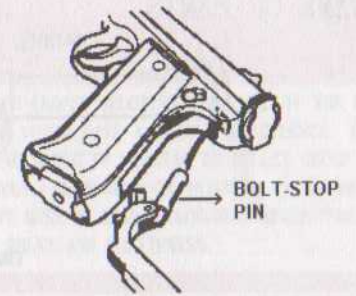

PLACE THE MAINSPRING BOLT-STOP PIN INTO THE BASE OF THE RECEIVER AND THROUGH ITS HOLE IN THE BARREL.

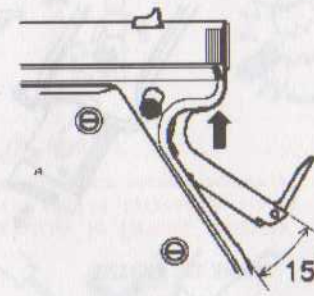

SWING THE MAINSPRING HOUSING.

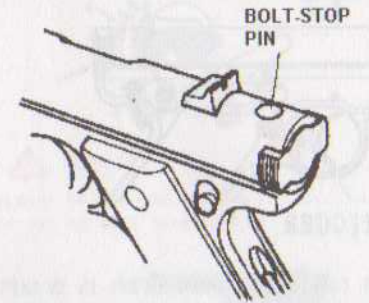

BE SURE THE BOLT-STOP PIN IS IN RIGHT POSITION.

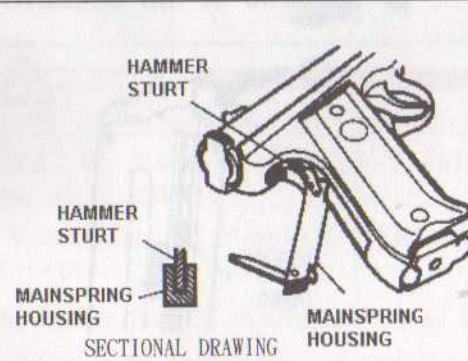

WITH THE STURT IN PLACE, LATCH THE MAINSPRING UNIT SHUT AND LOCK THE HOUSING LATCH.



LOCK THE HOUSING LATCH.

NO	NAME OF PART	PRICE	NO	NAME OF PART	PRICE
1	OUTER BARREL PART A	50	41	MAINSRING HOUSING	100
2	OUTER BARREL PART B	120	42	BOLT STOP PIN	50
3	FRONT SIGHT	30	43	BOLT STOP RETAINING PIN	10
4	INNER BARREL	120	44	MAINSRING PLUNGER	30
5	REAR SIGHT PART A	50	45	MAINSRING	30
6	REAR SIGHT PART B	50	46	MAINSRING DETENT	10
7	REAR SIGHT PART C	20	47	HOUSING LATCH	50
8	REAR SIGHT PIN	10	48	MAGAZINE LATCH	50
9	REAR SIGHT SCREW A	20	49	MAGAZINE LATCH SPRING	10
10	REAR SIGHT SPRING A	10	50	MAGAZINE LATCH PIN	10
11	REAR SIGHT SCREW B	20	51	GRIP PLATE L	70
12	REAR SIGHT SPRING B	20	52	GRIP PLATE R	70
13	REAR SIGHT PIN	10	53	GRIP PLATE SCREW	10
14	RECEIVER	200	54	MAGAZINE CASE	400
15	FRAME	300	55	VALVE CATCH	100
16	BOLT	150	56	MAGAZINE BASE	100
17	CAM SPRING	10	57	GAS VALVE	50
18	BARREL BUFFER	50	58	VALVE ORING A	10
19	BUFFER SPRING	10	59	VALVE ORING B	10
20	CHAMBER	40	60	VALVE SPRING	10
21	ADJUST RUBBER	20	61	VALVE CATCH ORING	10
22	BARREL LOCK WASHER	10	62	VALVE CATCH ORING	10
23	ADJUST SCREW	10	63	VALVE CATCH SCREW	10
24	RECEIVER BASE	150	64	VALVE CATCH PIN	10
25	BULLET STOP	30	65	FOLLOWER	30
26	BULLET STOP SPRING	10	66	FOLLOWER SPRING	30
27	BULLET STOP PIN	20	67	JOINT PACKING	20
28	FRONT LOCK	50	68	FILLING VALVE	50
29	CAM	50	69	GUIDE PACKING	20
30	FRONT LOCK PIN	20	70	MAGAZINE COLLAR	20
31	TRIGGER	80	71	BARREL SCREW	10
32	TRIGGER SPRING	20			
33	TRIGGER PIVOT	10			
34	DISCONNECTOR	50			
35	HAMMER	50			
36	HAMMER STURT	40			
37	HAMMER STURT PIN	20			
38	FIRING PIN	20			
39	SAFETY	50			
40	SAFETY HOOK	40			

## EXPLODE DRAWING

